



Is Now Part of



**ON Semiconductor®**

To learn more about ON Semiconductor, please visit our website at

[www.onsemi.com](http://www.onsemi.com)

ON Semiconductor and the ON Semiconductor logo are trademarks of Semiconductor Components Industries, LLC dba ON Semiconductor or its subsidiaries in the United States and/or other countries. ON Semiconductor owns the rights to a number of patents, trademarks, copyrights, trade secrets, and other intellectual property. A listing of ON Semiconductor's product/patent coverage may be accessed at [www.onsemi.com/site/pdf/Patent-Marking.pdf](http://www.onsemi.com/site/pdf/Patent-Marking.pdf). ON Semiconductor reserves the right to make changes without further notice to any products herein. ON Semiconductor makes no warranty, representation or guarantee regarding the suitability of its products for any particular purpose, nor does ON Semiconductor assume any liability arising out of the application or use of any product or circuit, and specifically disclaims any and all liability, including without limitation special, consequential or incidental damages. Buyer is responsible for its products and applications using ON Semiconductor products, including compliance with all laws, regulations and safety requirements or standards, regardless of any support or applications information provided by ON Semiconductor. "Typical" parameters which may be provided in ON Semiconductor data sheets and/or specifications can and do vary in different applications and actual performance may vary over time. All operating parameters, including "Typicals" must be validated for each customer application by customer's technical experts. ON Semiconductor does not convey any license under its patent rights nor the rights of others. ON Semiconductor products are not designed, intended, or authorized for use as a critical component in life support systems or any FDA Class 3 medical devices or medical devices with a same or similar classification in a foreign jurisdiction or any devices intended for implantation in the human body. Should Buyer purchase or use ON Semiconductor products for any such unintended or unauthorized application, Buyer shall indemnify and hold ON Semiconductor and its officers, employees, subsidiaries, affiliates, and distributors harmless against all claims, costs, damages, and expenses, and reasonable attorney fees arising out of, directly or indirectly, any claim of personal injury or death associated with such unintended or unauthorized use, even if such claim alleges that ON Semiconductor was negligent regarding the design or manufacture of the part. ON Semiconductor is an Equal Opportunity/Affirmative Action Employer. This literature is subject to all applicable copyright laws and is not for resale in any manner.



# FAN7171\_F085 High-Current High-Side Gate Drive IC

## Features

- Automotive qualified to AEC Q100
- Floating Channel for Bootstrap Operation to +600 V
- 4 A Sourcing and 4 A Sinking Current Driving Capability
- Common-Mode dv/dt Noise-Cancelling Circuit
- 3.3 V and 5 V Input Logic Compatible
- Output In-phase with Input Signal
- Under-Voltage Lockout for V<sub>BS</sub>
- 25 V Shunt Regulator on V<sub>DD</sub> and V<sub>BS</sub>
- 8-Lead, Small Outline Package

## Applications

- Common Rail Injection Systems
- DC-DC Converter
- Motor Drive (Electric Power Steering, Fans)

## Related Product Resources

- [FAN7171\\_F085 Product Folder](#)
- [AN-6076 Design and Application Guide of Bootstrap Circuit for High-Voltage Gate-Drive IC](#)
- [AN-8102 200 Recommendations to Avoid Short Pulse Width Issues in HVIC Gate Driver Applications](#)
- [AN-9052 Design Guide for Selection of Bootstrap Components](#)
- [AN-4171 FAN7085 High-Side Gate Driver- Internal Recharge Path Design Considerations](#)

## Description

The FAN7171\_F085 is a monolithic high-side gate drive IC that can drive high-speed MOSFETs and IGBTs that operate up to +600 V. It has a buffered output stage with all NMOS transistors designed for high pulse current driving capability and minimum cross-conduction.

Fairchild's high-voltage process and common-mode noise-canceling techniques provide stable operation of the high-side driver under high-dv/dt noise circumstances. An advanced level-shift circuit offers high-side gate driver operation up to V<sub>S</sub>=-9.8 V (typical) for V<sub>BS</sub>=15 V.

The UVLO circuit prevents malfunction when V<sub>BS</sub> is lower than the specified threshold voltage.

The high-current and low-output voltage-drop feature make this device suitable for sustaining switch drivers and energy-recovery switch drivers in automotive motor drive inverters, switching power supplies, and high-power DC-DC converter applications.



Figure 1. 8-Lead, SOIC, Narrow Body

## Ordering Information

Part Number	Operating Temperature Range	Package	Packing Method
FAN7171M_F085	-40°C ~ 125°C	8-Lead, Small Outline Integrated Circuit (SOIC), JEDEC MS-012, .150 inch Narrow Body	Tube
FAN7171MX_F085			Tape & Reel

### Note:

1. These devices passed wave soldering test by JESD22A-111.
2. A suffix as "...F085P" has been temporarily introduced in order to manage a double source strategy as Fairchild has officially announced in Aug 2014.

### Typical Application

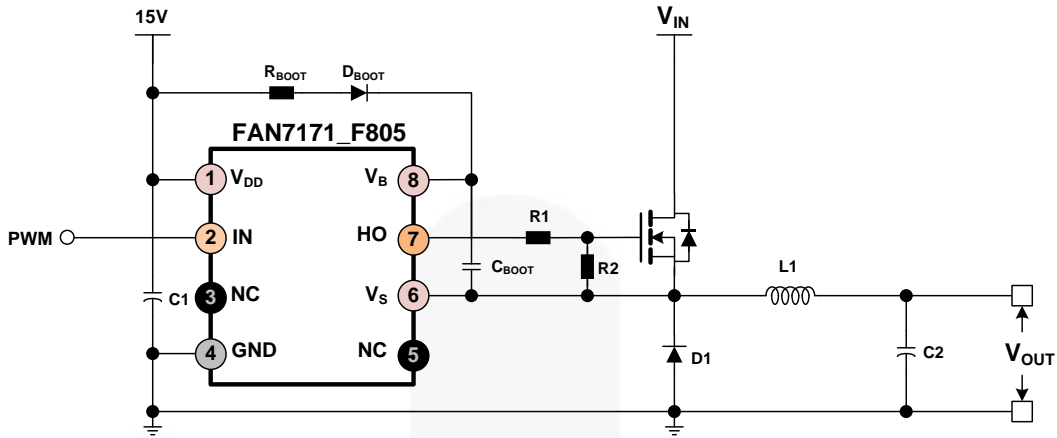

Figure 2. Typical Application

### Block Diagram

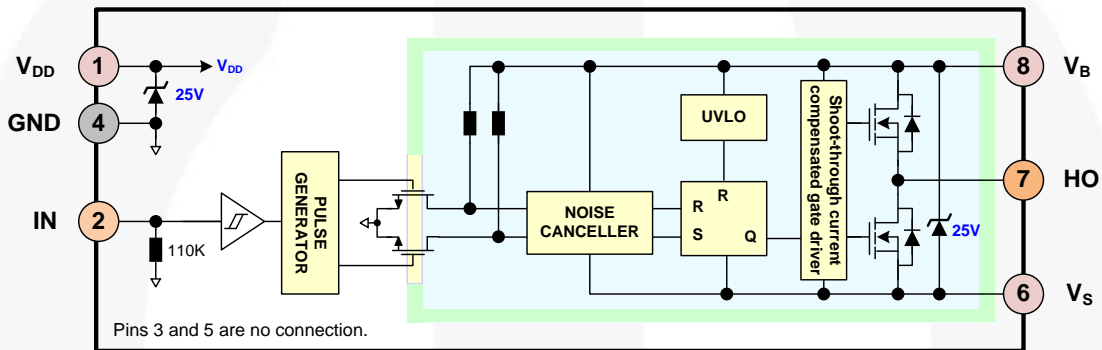

Figure 3. Block Diagram

### Pin Configuration

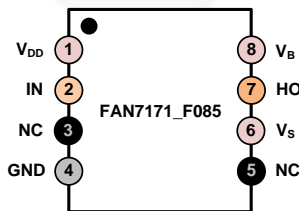

Figure 4. Pin Assignment (Top Through View)

### Pin Descriptions

Pin #	Name	Description
1	V <sub>DD</sub>	Supply Voltage
2	IN	Logic Input for High-Side Gate Driver Output
3	NC	No Connection
4	GND	Ground
5	NC	No Connection
6	V <sub>s</sub>	High-Voltage Floating Supply Return
7	HO	High-Side Driver Output
8	V <sub>b</sub>	High-Side Floating Supply

## Absolute Maximum Ratings

Stresses exceeding the absolute maximum ratings may damage the device. The device may not function or be operable above the recommended operating conditions and stressing the parts to these levels is not recommended. In addition, extended exposure to stresses above the recommended operating conditions may affect device reliability. The absolute maximum ratings are stress ratings only.

Symbol	Characteristics	Min.	Max.	Unit
$V_S$	High-Side Floating Offset Voltage	$V_B - V_{SHUNT}$	$V_B + 0.3$	V
$V_B$	High-Side Floating Supply Voltage <sup>(3)</sup>	-0.3	625.0	V
$V_{HO}$	High-Side Floating Output Voltage	$V_S - 0.3$	$V_B + 0.3$	V
$V_{DD}$	Low-Side and Logic Supply Voltage <sup>(3)</sup>	-0.3	$V_{SHUNT}$	V
$V_{IN}$	Logic Input Voltage	-0.3	$V_{DD} + 0.3$	V
dV <sub>S</sub> /dt	Allowable Offset Voltage Slew Rate		±50	V/ns
$P_D$	Power Dissipation <sup>(4,5,6)</sup>		0.625	W
$\theta_{JA}$	Thermal Resistance		200	°C/W
$T_J$	Junction Temperature	-55	150	°C
$T_{STG}$	Storage Temperature	-55	150	°C
$T_A$	Operating Ambient Temperature	-40	125	°C
ESD	Human Body Model (HBM)		1500	V
	Charge Device Model (CDM)		500	

### Notes:

- This IC contains a shunt regulator on  $V_{DD}$  and  $V_{BS}$  with a normal breakdown voltage of 25 V. Please note that this supply pin should not be driven by a low-impedance voltage source greater than the  $V_{SHUNT}$  specified in the Electrical Characteristics section.
- Mounted on 76.2 x 114.3 x 1.6 mm PCB (FR-4 glass epoxy material).
- Refer to the following standards:  
JESD51-2: Integral circuits thermal test method environmental conditions, natural convection, and  
JESD51-3: Low effective thermal conductivity test board for leaded surface-mount packages.
- Do not exceed power dissipation ( $P_D$ ) under any circumstances.

## Recommended Operating Conditions

The Recommended Operating Conditions table defines the conditions for actual device operation. Recommended operating conditions are specified to ensure optimal performance. Fairchild does not recommend exceeding them or designing to Absolute Maximum Ratings.

Symbol	Parameter	Min.	Max.	Unit
$V_{BS}$	High-Side Floating Supply Voltage	$V_S + 10$	$V_S + 20$	V
$V_S$	High-Side Floating Supply Offset Voltage (DC)	$6 - V_{DD}$	600	V
	High-Side Floating Supply Offset Voltage (Transient)	-15 (~170) -7 (~400)		
$V_{HO}$	High-Side Output Voltage	$V_S$	$V_B$	V
$V_{IN}$	Logic Input Voltage	GND	$V_{DD}$	V
$V_{DD}$	Supply Voltage	10	20	V

## Electrical Characteristics

$V_{BIAS}$  ( $V_{DD}$ ,  $V_{BS}$ ) = 15 V,  $-40^{\circ}\text{C} \leq T_A \leq 125^{\circ}\text{C}$ , unless otherwise specified. The  $V_{IN}$  and  $I_{IN}$  parameters are referenced to GND. The  $V_O$  and  $I_O$  parameters are relative to  $V_S$  and are applicable to the respective output HO.

Symbol	Parameter	Conditions	Min.	Typ.	Max.	Unit
<b>Power Supply Section</b>						
$I_{QDD}$	Quiescent $V_{DD}$ Supply Current	$V_{IN}=0$ V or 5 V		25	70	$\mu\text{A}$
$I_{PDD}$	Operating $V_{DD}$ Supply Current	$f_{IN}=20$ kHz, No Load		35	100	$\mu\text{A}$
<b>Bootstrapped Supply Section</b>						
$V_{BSUV+}$	$V_{BS}$ Supply Under-Voltage Positive-Going Threshold Voltage	$V_{BS}=\text{Sweep}$	8.2	9.2	10.2	V
$V_{BSUV-}$	$V_{BS}$ Supply Under-Voltage Negative-Going Threshold Voltage	$V_{BS}=\text{Sweep}$	7.5	8.5	9.5	V
$V_{BSHYS}$	$V_{BS}$ Supply UVLO Hysteresis Voltage	$V_{BS}=\text{Sweep}$		0.6		V
$I_{LK}$	Offset Supply Leakage Current	$V_B=V_S=600$ V			50	$\mu\text{A}$
$I_{QBS}$	Quiescent $V_{BS}$ Supply Current	$V_{IN}=0$ V or 5 V		60	120	$\mu\text{A}$
$I_{PBS}$	Operating $V_{BS}$ Supply Current	$C_{LOAD}=1$ nF, $f_{IN}=20$ kHz, RMS Value		0.73	2.80	mA
<b>Shunt Regulator Section</b>						
$V_{SHUNT}$	$V_{DD}$ and $V_{BS}$ Shunt Regulator Clamping Voltage	$I_{SHUNT}=5$ mA	23	25		V
<b>Input Logic Section (IN)</b>						
$V_{IH}$	Logic "1" Input Voltage		2.5			V
$V_{IL}$	Logic "0" Input Voltage				0.8	V
$I_{IN+}$	Logic Input High Bias Current	$V_{IN}=5$ V		45	125	$\mu\text{A}$
$I_{IN-}$	Logic Input Low Bias Current	$V_{IN}=0$ V			2	$\mu\text{A}$
$R_{IN}$	Input Pull-down Resistance		40	110		k $\Omega$
<b>Gate Driver Output Section (HO)</b>						
$V_{OH}$	High Level Output Voltage ( $V_{BIAS} - V_O$ )	No Load			1.5	V
$V_{OL}$	Low Level Output Voltage	No Load			35	mV
$I_{O+}$	Output High, Short-Circuit Pulsed Current <sup>(7)</sup>	$V_{HO}=0$ V, $V_{IN}=5$ V, $PW \leq 10$ $\mu\text{s}$	3.0	4.0		A
$I_{O-}$	Output Low, Short-Circuit Pulsed Current <sup>(7)</sup>	$V_{HO}=15$ V, $V_{IN}=0$ V, $PW \leq 10$ $\mu\text{s}$	3.0	4.0		A
$V_S$	Allowable Negative $V_S$ Pin Voltage for IN Signal Propagation to HO			-9.8	-7.0	V

### Note:

7. These parameters guaranteed by design.

## Dynamic Electrical Characteristics

$V_{BIAS}$  ( $V_{DD}$ ,  $V_{BS}$ ) = 15 V,  $V_S=\text{GND}=0$  V,  $C_L=1000$  pF, and  $-40^{\circ}\text{C} \leq T_A \leq 125^{\circ}\text{C}$ , unless otherwise specified.

Symbol	Parameter	Conditions	Min.	Typ.	Max.	Unit
$t_{ON}$	Turn-On Propagation Delay	$V_S=0$ V		150	210	ns
$t_{OFF}$	Turn-Off Propagation Delay	$V_S=0$ V		150	210	ns
$t_R$	Turn-On Rise Time			25	50	ns
$t_F$	Turn-Off Fall Time			15	45	ns

### Typical Performance Characteristics

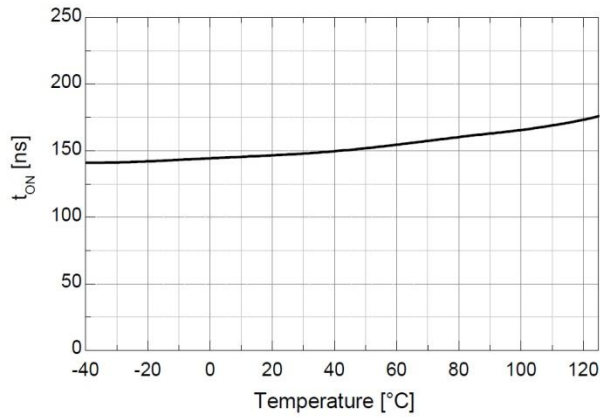

**Figure 5. Turn-On Propagation Delay vs. Temperature**

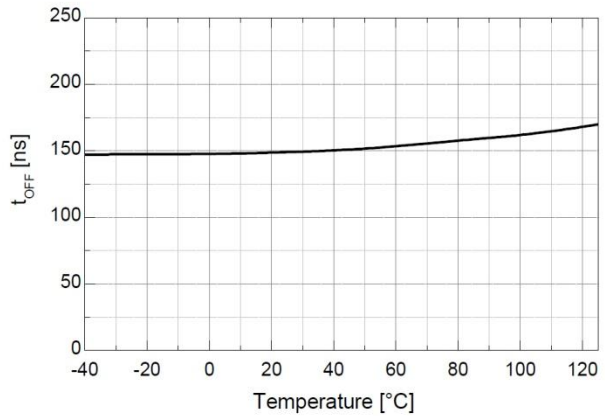

**Figure 6. Turn-Off Propagation Delay vs. Temperature**

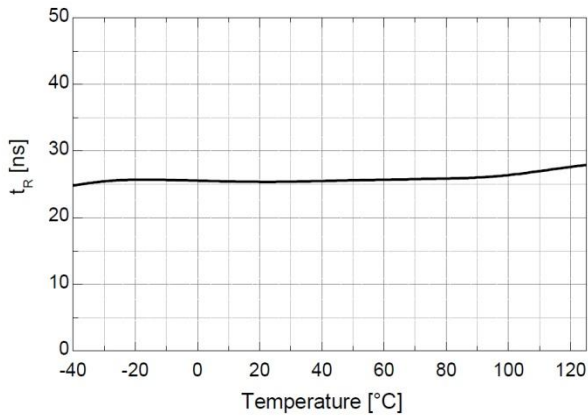

**Figure 7. Turn-On Rise Time vs. Temperature**

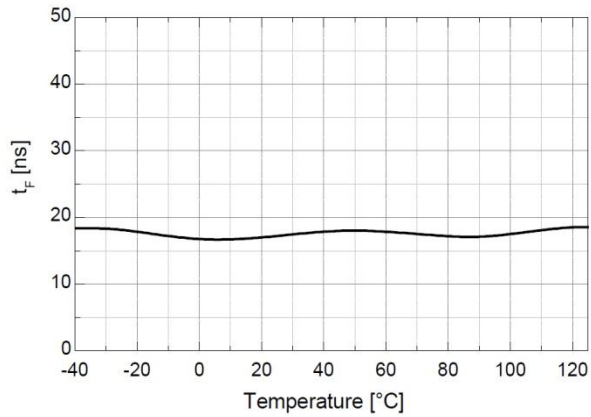

**Figure 8. Turn-Off Fall Time vs. Temperature**

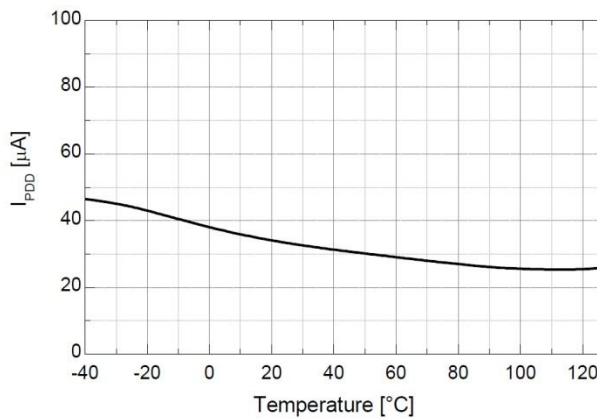

**Figure 9. Operating V<sub>DD</sub> Supply Current vs. Temperature**

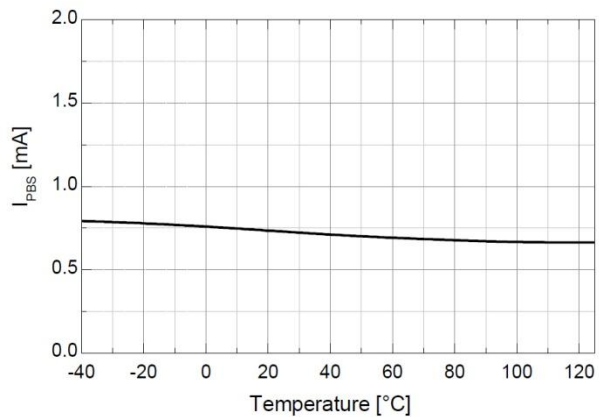

**Figure 10. Operating V<sub>BS</sub> Supply Current vs. Temperature**

### Typical Performance Characteristics

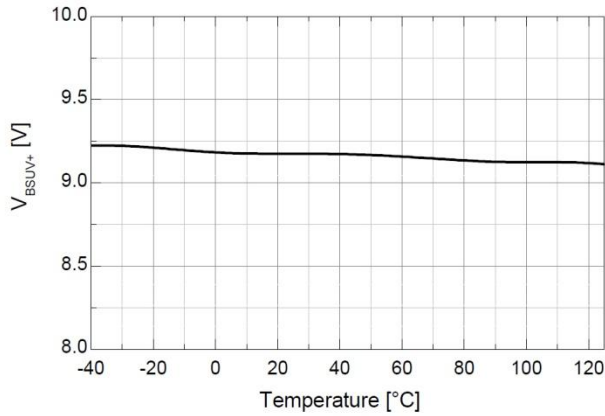

Figure 11.  $V_{BS\ UVLO+}$  vs. Temperature

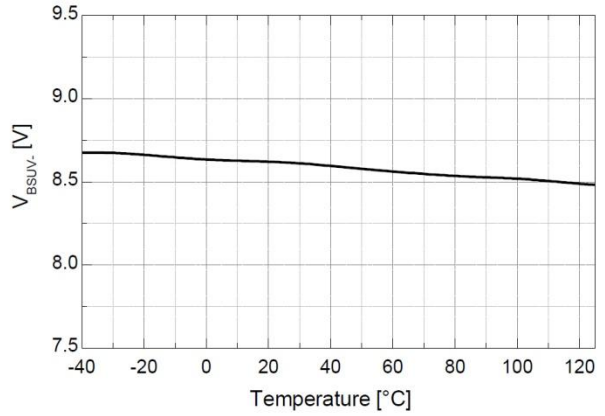

Figure 12.  $V_{BS\ UVLO-}$  vs. Temperature

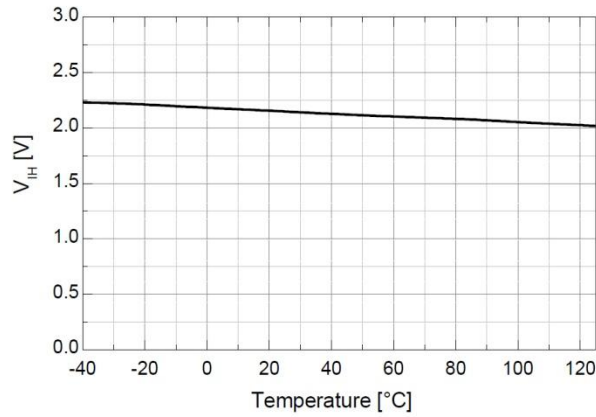

Figure 13. Logic High Input Voltage vs. Temperature

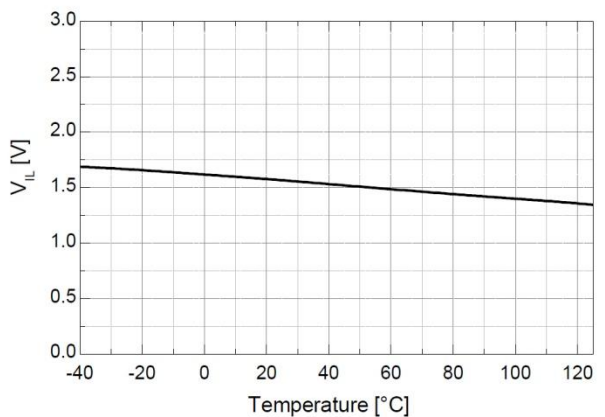

Figure 14. Logic Low Input Voltage vs. Temperature

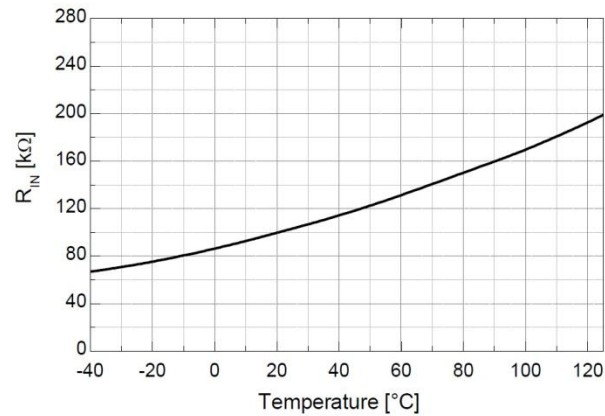

Figure 15. Input Pull-Down Resistance vs. Temperature

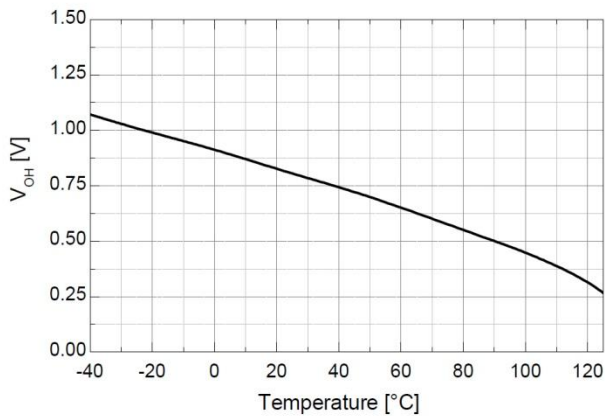

Figure 16. High-Level Output Voltage vs. Temperature

Typical Performance Characteristics

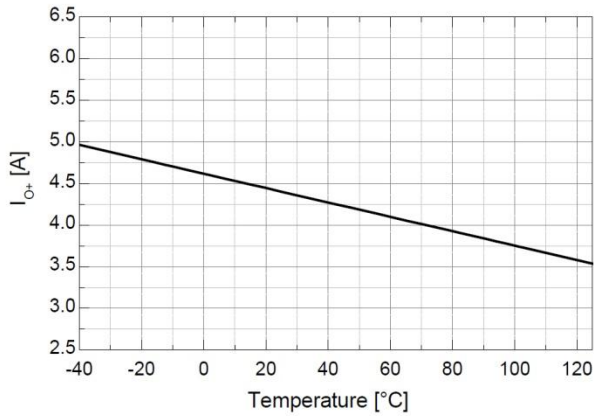

Figure 17. Output High, Short-Circuit Pulsed Current vs. Temperature

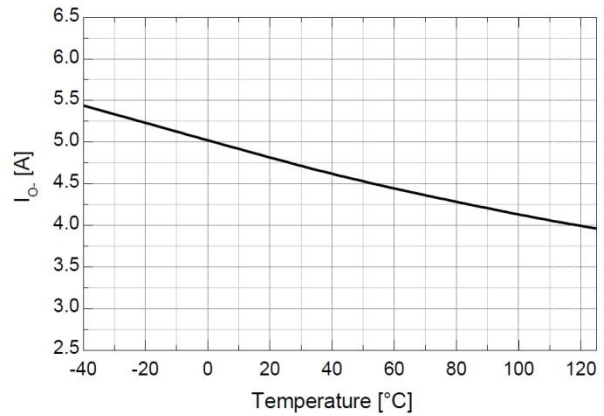

Figure 18. Output Low, Short-Circuit Pulsed Current vs. Temperature

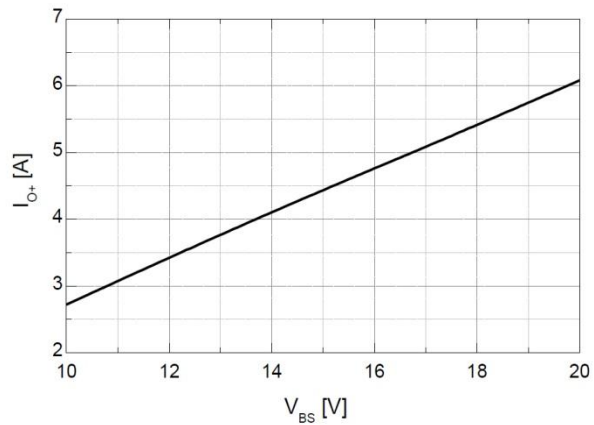

Figure 19. Output High, Short-Circuit Pulsed Current vs. Supply Voltage

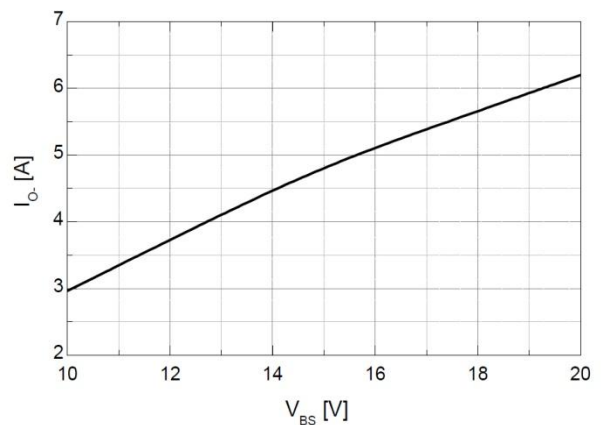

Figure 20. Output Low, Short-Circuit Pulsed Current vs. Supply Voltage

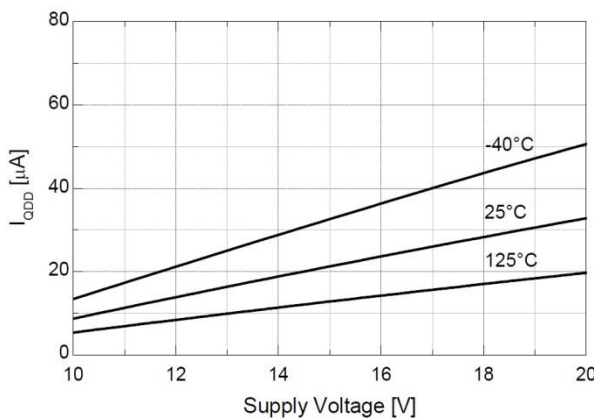

Figure 21. Quiescent  $V_{DD}$  Supply Current vs. Supply Voltage

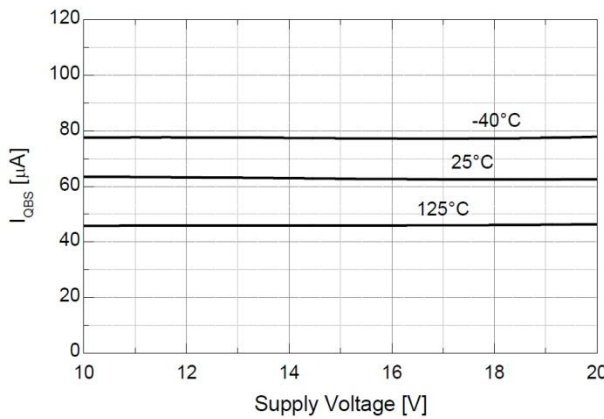

Figure 22. Quiescent  $V_{BS}$  Supply Current vs. Supply Voltage



### Switching Time Definitions

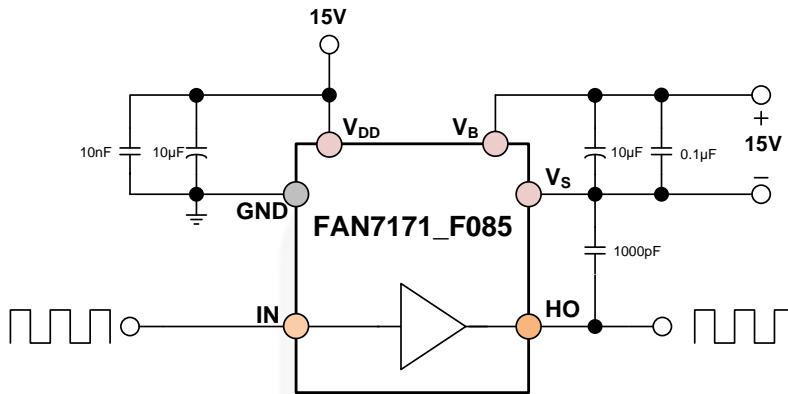

Figure 23. Switching Time Test Circuit (Referenced 8-SOIC)

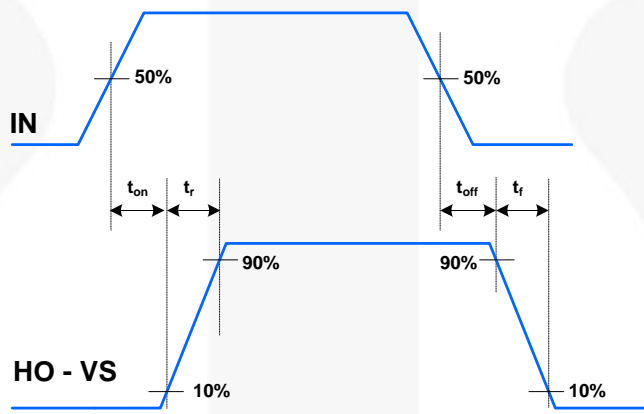

Figure 24. Switching Time Waveform Definitions

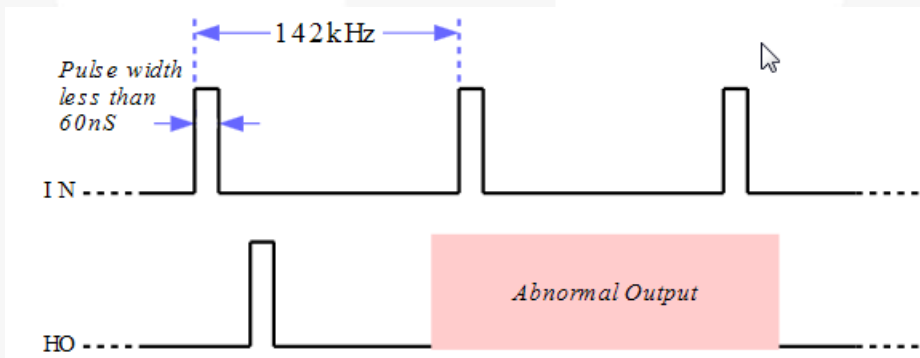

Figure 25. Abnormal Output Waveform with Short Pulse Width

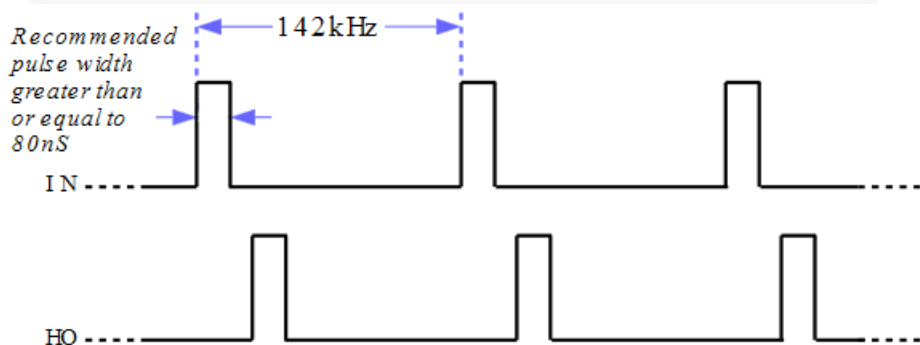
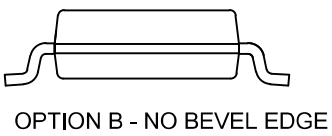
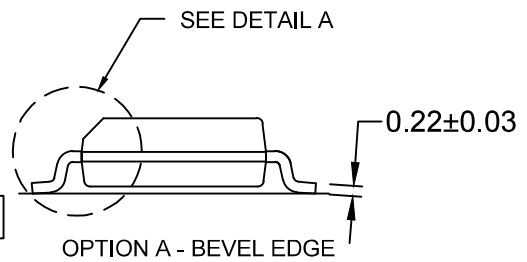
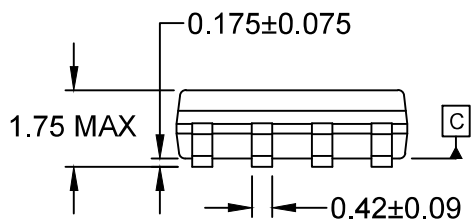
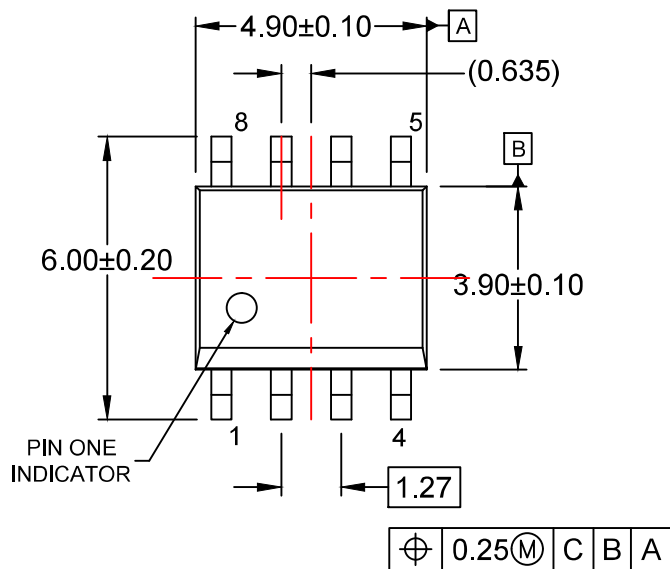

Figure 26. Recommendation of Pulse Width Output Waveform



NOTES:

- A) THIS PACKAGE CONFORMS TO JEDEC MS-012, VARIATION AA.
- B) ALL DIMENSIONS ARE IN MILLIMETERS.
- C) DIMENSIONS DO NOT INCLUDE MOLD FLASH OR BURRS.
- D) LANDPATTERN STANDARD: SOIC127P600X175-8M
- E) DRAWING FILENAME: M08Arev16



ON Semiconductor and  are trademarks of Semiconductor Components Industries, LLC dba ON Semiconductor or its subsidiaries in the United States and/or other countries. ON Semiconductor owns the rights to a number of patents, trademarks, copyrights, trade secrets, and other intellectual property. A listing of ON Semiconductor's product/patent coverage may be accessed at [www.onsemi.com/site/pdf/Patent-Marking.pdf](http://www.onsemi.com/site/pdf/Patent-Marking.pdf). ON Semiconductor reserves the right to make changes without further notice to any products herein. ON Semiconductor makes no warranty, representation or guarantee regarding the suitability of its products for any particular purpose, nor does ON Semiconductor assume any liability arising out of the application or use of any product or circuit, and specifically disclaims any and all liability, including without limitation special, consequential or incidental damages. Buyer is responsible for its products and applications using ON Semiconductor products, including compliance with all laws, regulations and safety requirements or standards, regardless of any support or applications information provided by ON Semiconductor. "Typical" parameters which may be provided in ON Semiconductor data sheets and/or specifications can and do vary in different applications and actual performance may vary over time. All operating parameters, including "Typicals" must be validated for each customer application by customer's technical experts. ON Semiconductor does not convey any license under its patent rights nor the rights of others. ON Semiconductor products are not designed, intended, or authorized for use as a critical component in life support systems or any FDA Class 3 medical devices or medical devices with a same or similar classification in a foreign jurisdiction or any devices intended for implantation in the human body. Should Buyer purchase or use ON Semiconductor products for any such unintended or unauthorized application, Buyer shall indemnify and hold ON Semiconductor and its officers, employees, subsidiaries, affiliates, and distributors harmless against all claims, costs, damages, and expenses, and reasonable attorney fees arising out of, directly or indirectly, any claim of personal injury or death associated with such unintended or unauthorized use, even if such claim alleges that ON Semiconductor was negligent regarding the design or manufacture of the part. ON Semiconductor is an Equal Opportunity/Affirmative Action Employer. This literature is subject to all applicable copyright laws and is not for resale in any manner.

## PUBLICATION ORDERING INFORMATION

### LITERATURE FULFILLMENT:

Literature Distribution Center for ON Semiconductor  
19521 E. 32nd Pkwy, Aurora, Colorado 80011 USA  
**Phone:** 303-675-2175 or 800-344-3860 Toll Free USA/Canada  
**Fax:** 303-675-2176 or 800-344-3867 Toll Free USA/Canada  
**Email:** [orderlit@onsemi.com](mailto:orderlit@onsemi.com)

**N. American Technical Support:** 800-282-9855 Toll Free  
USA/Canada  
**Europe, Middle East and Africa Technical Support:**  
Phone: 421 33 790 2910  
**Japan Customer Focus Center**  
Phone: 81-3-5817-1050

**ON Semiconductor Website:** [www.onsemi.com](http://www.onsemi.com)  
**Order Literature:** <http://www.onsemi.com/orderlit>  
For additional information, please contact your local  
Sales Representative